

ISOMETRIC VIEW

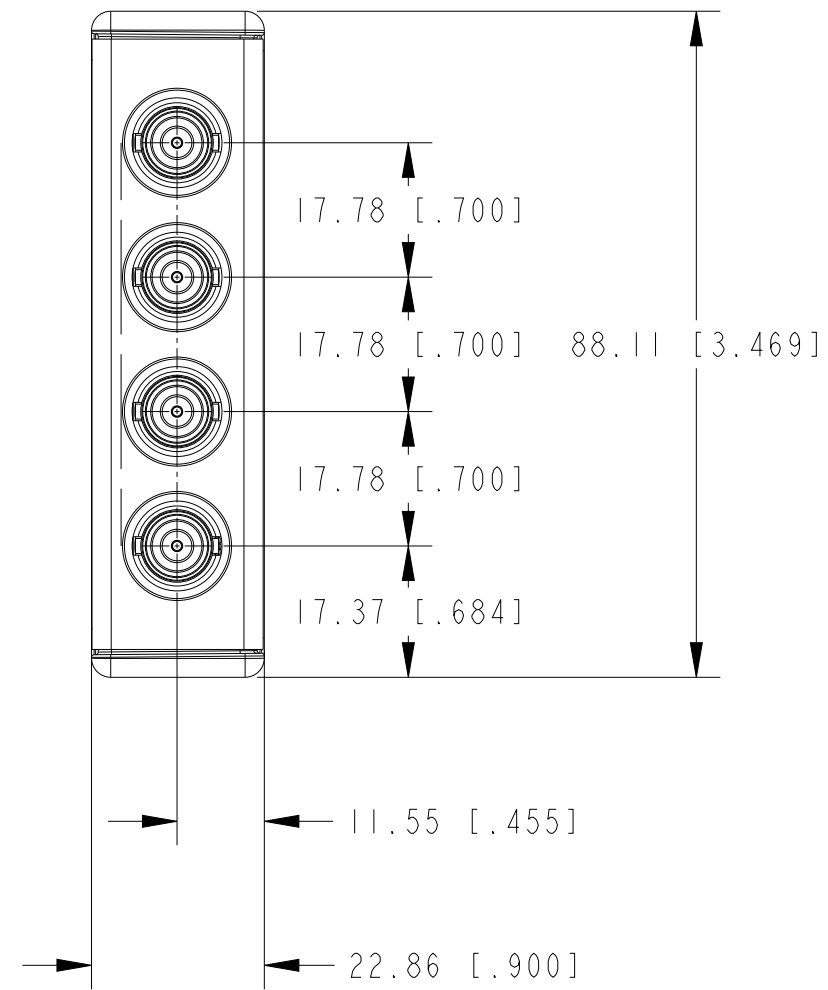
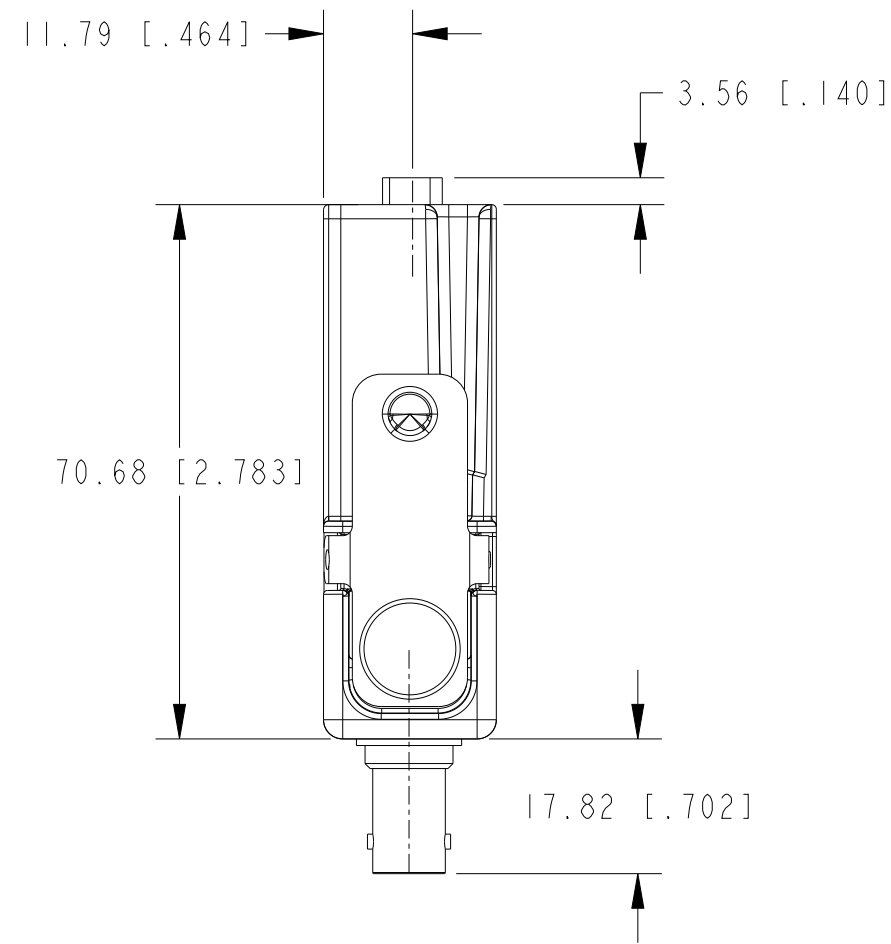
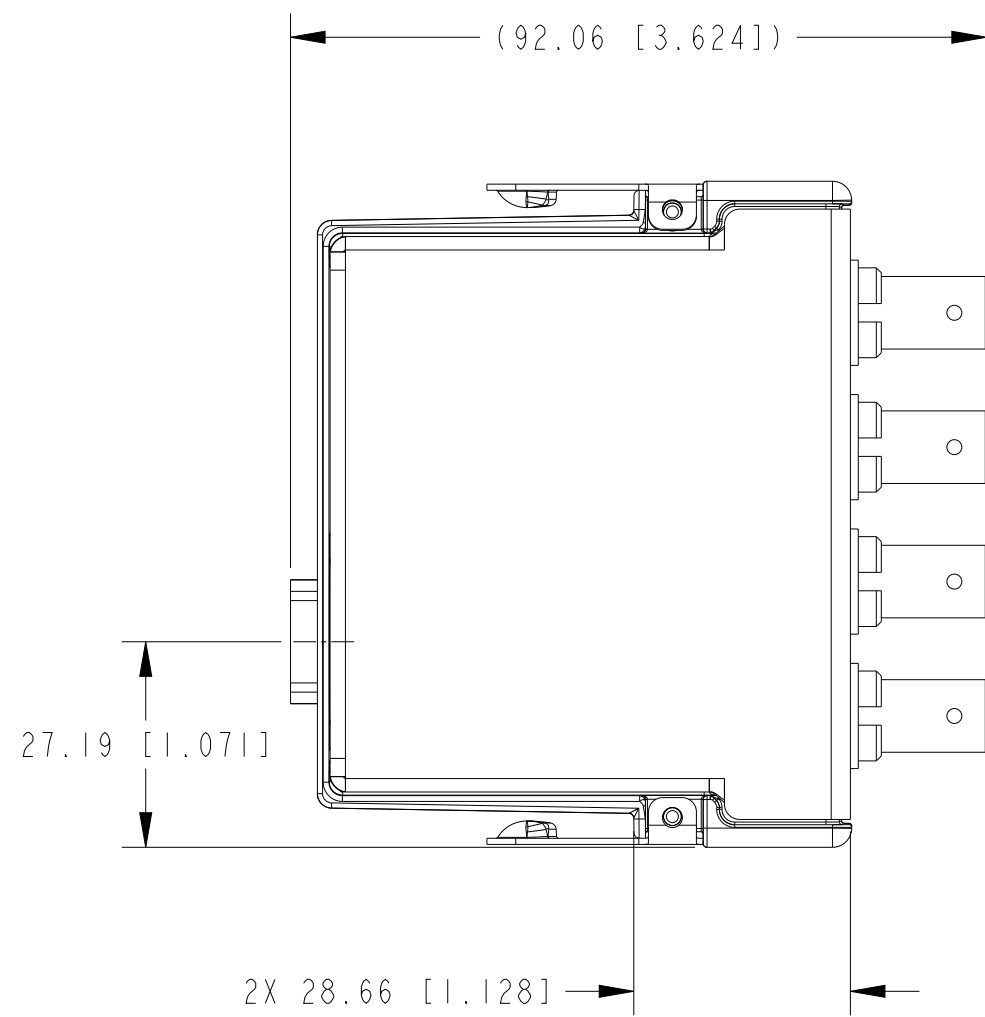

METRIC

CUSTOMER DRAWING

UNLESS OTHERWISE SPECIFIED
 DIMENSIONS ARE IN MILLIMETERS
 AND [INCHES]



NI.COM
 AUSTIN, TEXAS

DO NOT SCALE DRAWING

TITLE

NI 9223 BNC

THIRD ANGLE PROJECTION

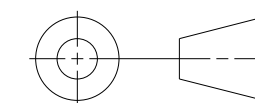

SIZE CODE IDENT NO. MM/DD/YYYY

C7U296

03/14/2024

SCALE: 1/1

SHEET 1 OF 1

2. DIMENSIONS IN () ARE FOR REFERENCE ONLY.
 1. REFER TO PRODUCT MANUAL ON NI.COM FOR MORE DETAILS
 NOTES: UNLESS OTHERWISE SPECIFIED.